

# NOUKIES SA

**Tiroir 200 cm MONT BLANC  
F1320.22**

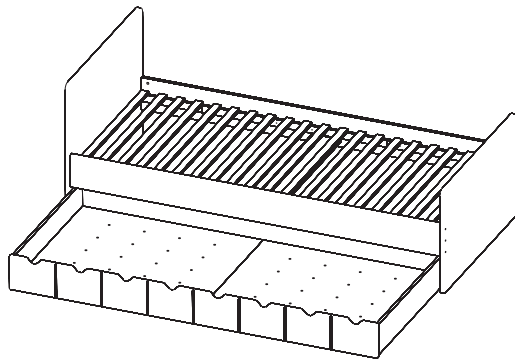

## PRINCIPE DE MONTAGE

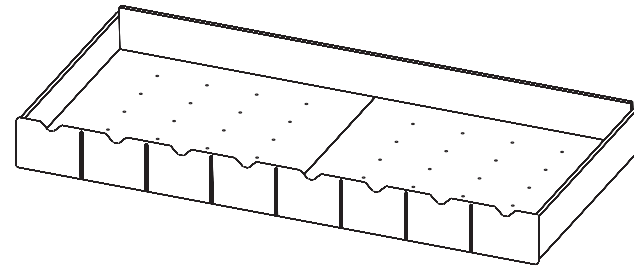
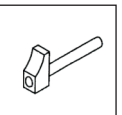
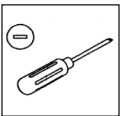
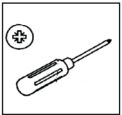
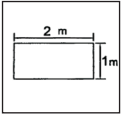
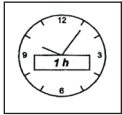
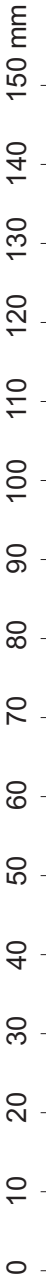
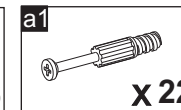
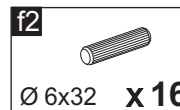
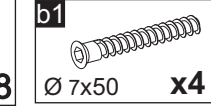
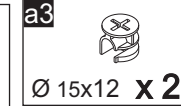
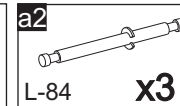
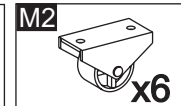
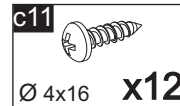
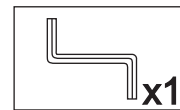
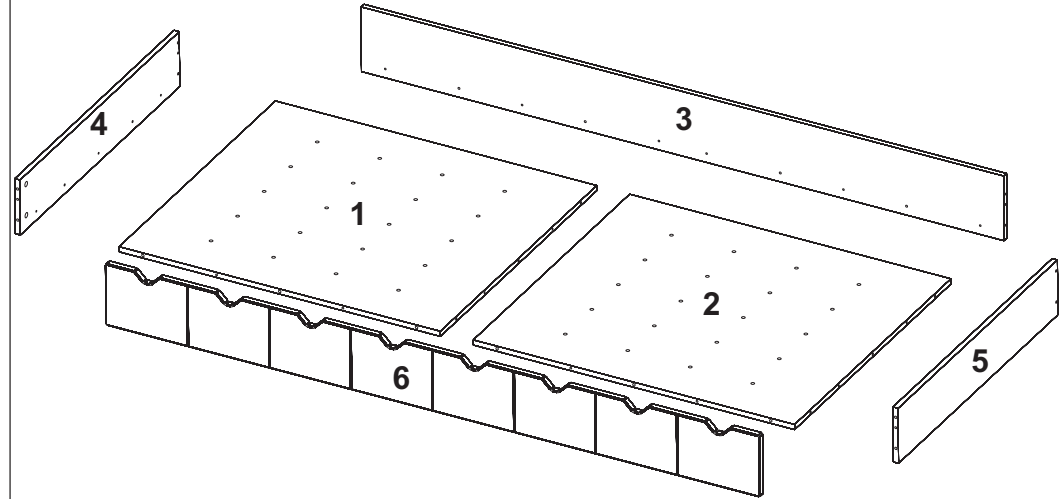
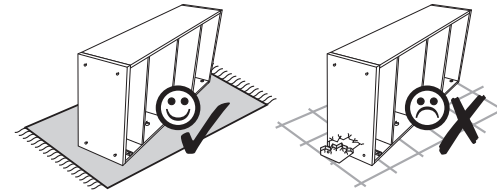
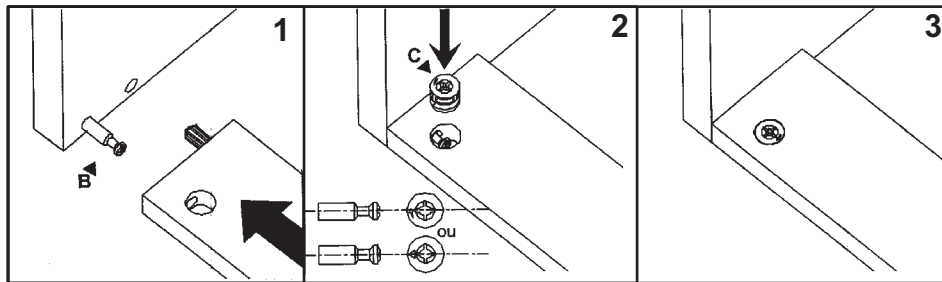

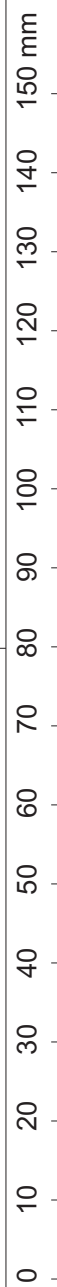
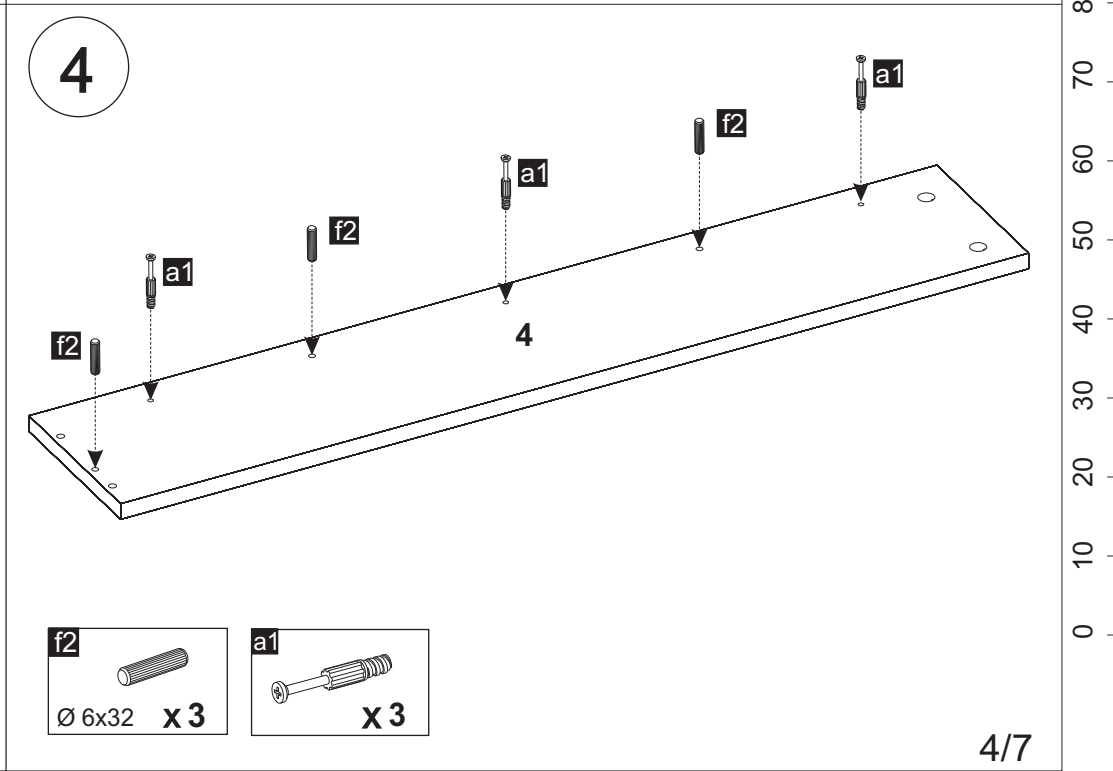
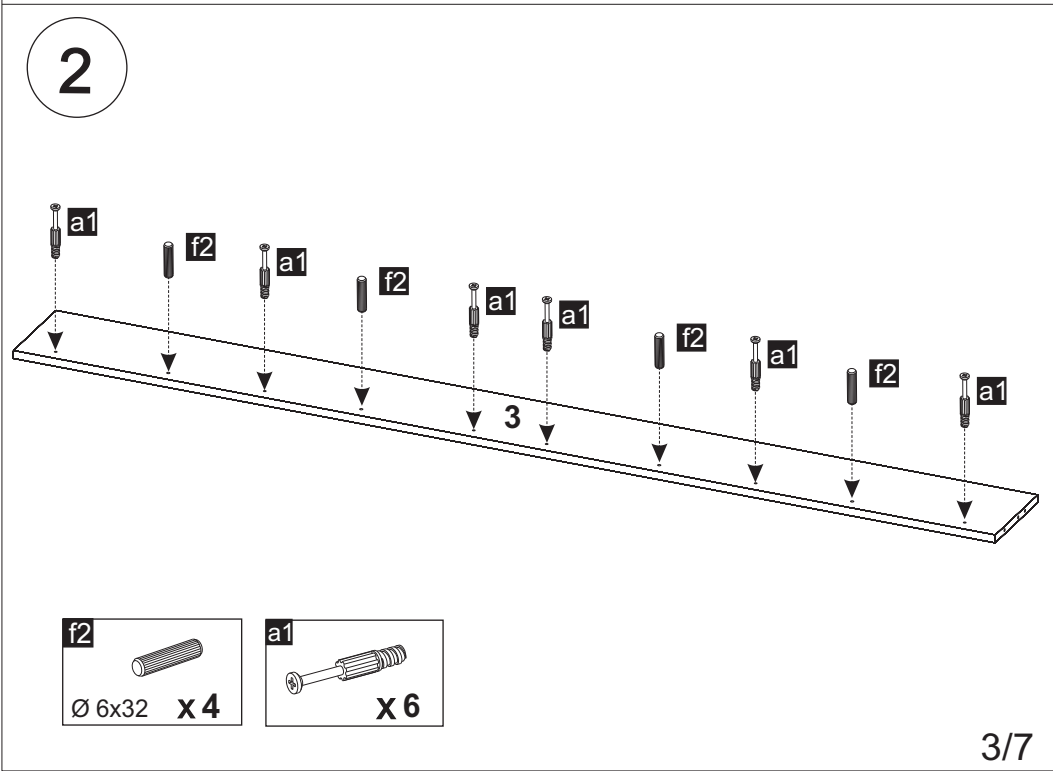
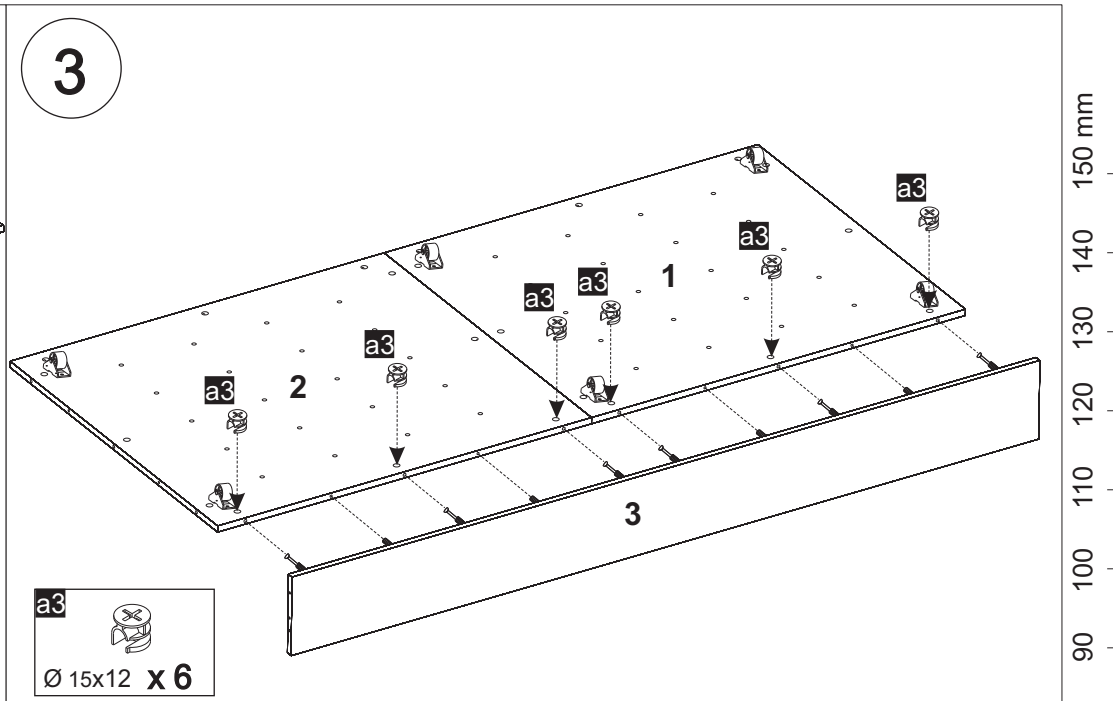
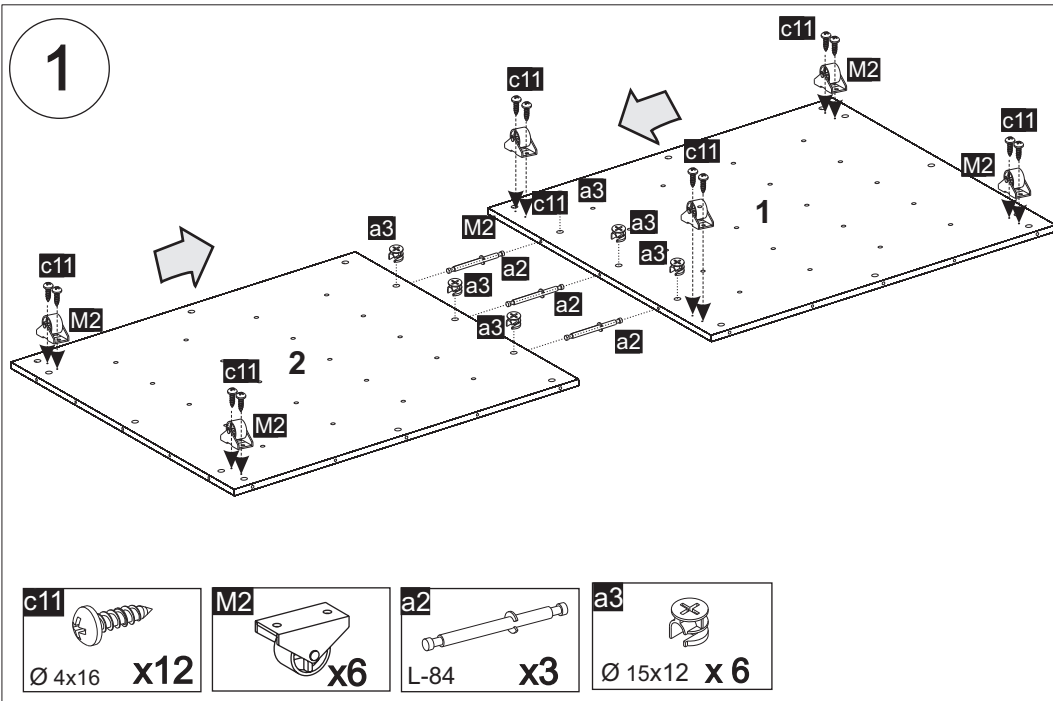

5

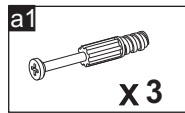
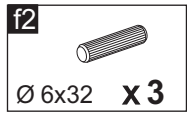
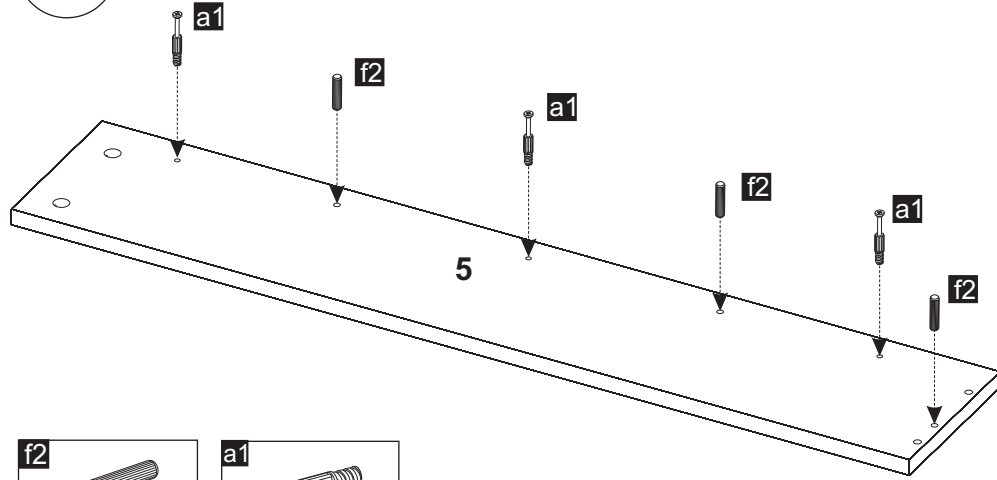

7

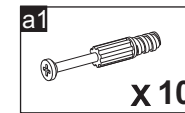
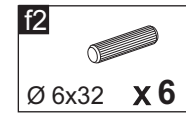
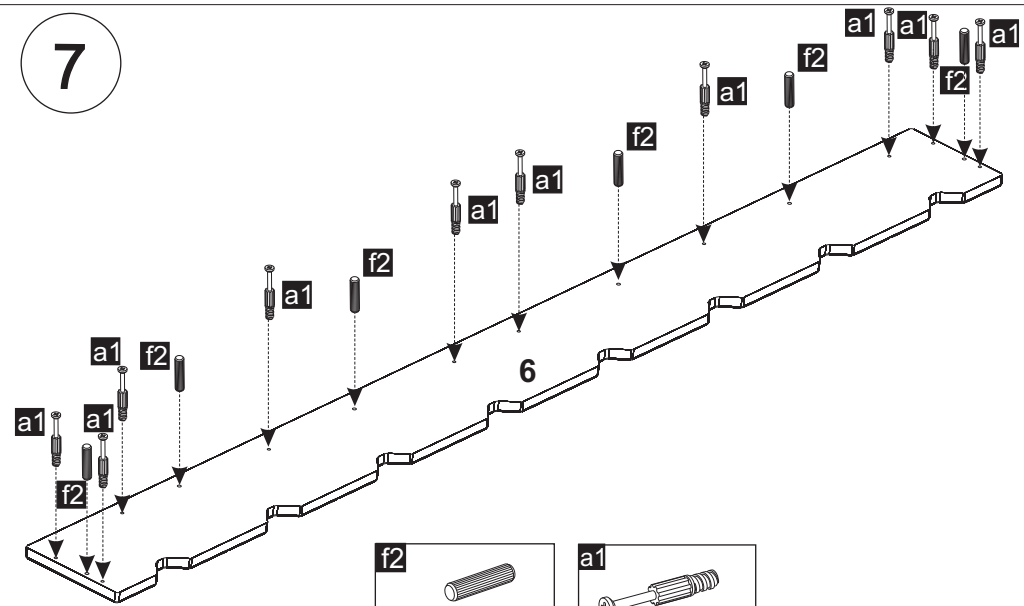

6

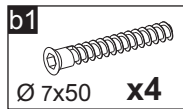
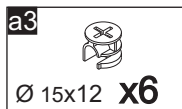
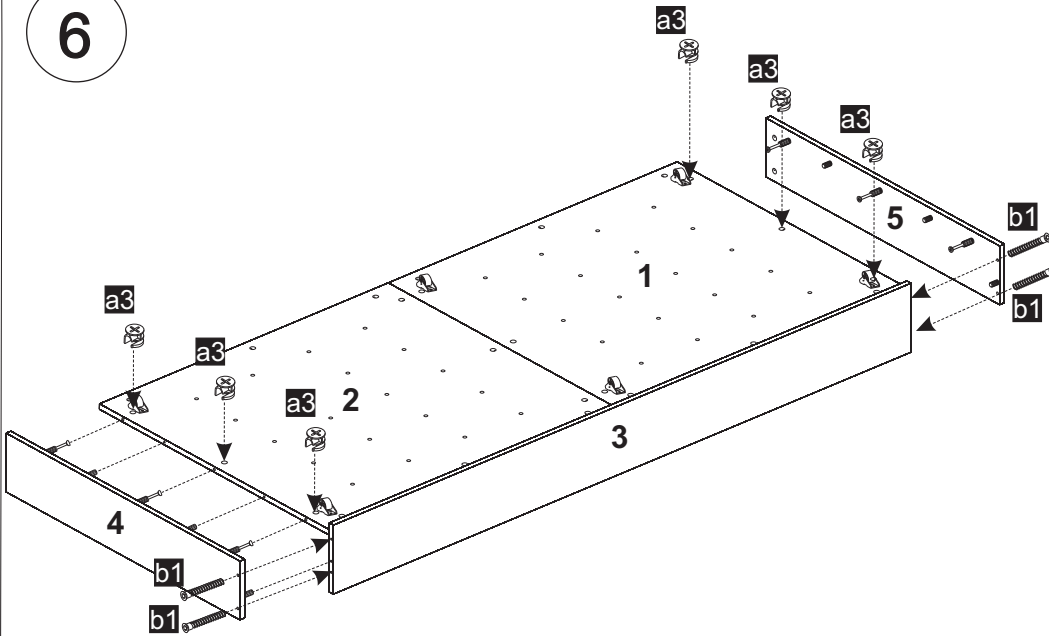

8

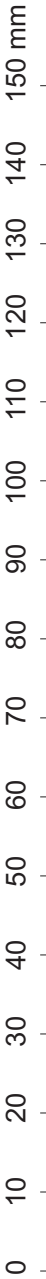
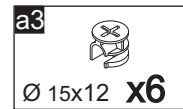
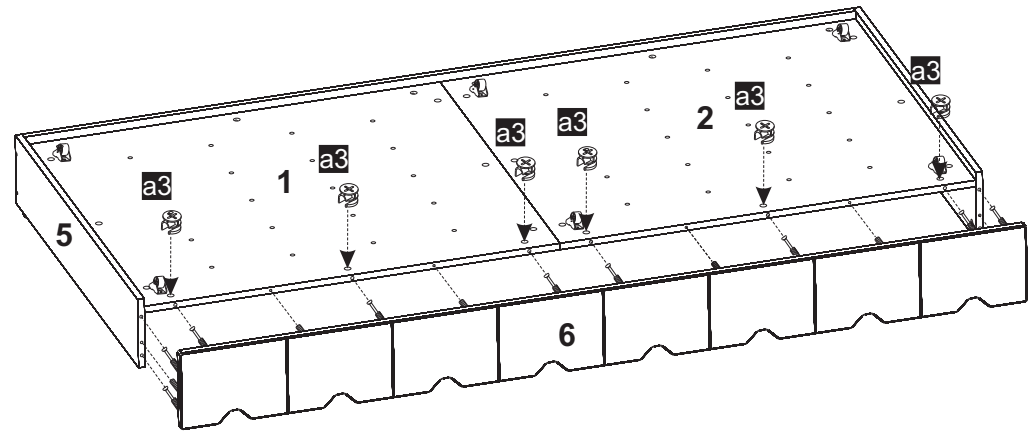

9

